



AuGlide[®],
SY and SP



BIMETAL BEARING SOLUTIONS FOR LUBRICATED APPLICATIONS

GGB Company History

FOR MORE THAN 120 YEARS, GGB HAS IMPROVED SURFACE ENGINEERING TO MOVE THE WORLD FORWARD.

GGB began in 1899 as Glacier Antifriction Metal Company, producing plain bearings and introducing many successful new products to the market, including internationally recognized polymer materials. Over the past 120 years, our company has continued forming strategic partnerships, continuously expanding into a global network of manufacturing facilities, increasing production capabilities and resources to become who we are today: world leaders in tribological innovation.

Today, our products can be found everywhere – from scientific vessels at the bottom of the ocean to race cars speeding down the tarmac to jumbo jets slicing through the sky to the Curiosity rover exploring the surface of Mars.

Throughout our history, safety, excellence and respect have formed the foundational values for the entire GGB family. They are of paramount importance as we seek to maximize personal possibility, achieve excellence and establish open, creative work environments with the highest safety standards in the industry.

SAFETY

GGB's deep-rooted culture of safety places a relentless focus on creating a secure, healthy work environment for all. A core value of GGB, safety is critical at all levels of business in order to achieve our goal of having the safest employees in the industry.

EXCELLENCE

A world-class organization is built by fostering excellence throughout the company, across all roles. Our world-class manufacturing plants are certified in quality and excellence in the industry according to ISO 9001, IATF 16949, ISO 14001 and ISO 45001, allowing us to access the industry's best practices while aligning our quality management system with global standards.

RESPECT

We believe that respect is consistent with the growth of individuals and groups. Our teams work together with mutual respect regardless of background, nationality or function, embracing the diversity of people and learning from one another.

The GGB Advantage

With 8 manufacturing facilities around the world, including cutting edge R&D facilities, flexible production platforms and extensive customer support networks, GGB offers unmatched technical expertise combined with razor sharp responsiveness and customized solutions. Our global presence and local logistics networks ensure our customers receive only the highest quality bearing solutions, in a timely manner and with extensive engineering support. **We don't just make products, we build partnerships. That's the GGB Advantage.**

The Highest Standards in Quality

Our world-class manufacturing plants in the United States, Brazil, China, Germany, France and Slovakia are certified in quality and excellence according to ISO 9001, IATF 16949, ISO 14001 and ISO 45001. This allows us to access the industry's best practices while aligning our management system with global standards.

For a complete listing of our certifications, please visit our website:

www.ggbearings.com/en/company/certificates



Content

	PAGE		PAGE		PAGE
Applications	4	Physical and Mechanical Properties	6	Product Information	8
Material Structure	5	Installation	7	Standard Products	9
Available Forms	5	Lubrication	7	Bearing Application Data Sheet	11
Characteristics	6	Cutting and Machining	8		

AuGlide® , SY and SP Bimetal Bearings

The more and more demanding specifications of today's high performance equipment and systems require that the bearings operate not only under severe working conditions with minimal or no maintenance but that they also offer increased reliability and durability with lower operating costs. With more than 100 years of experience and expertise in tribology, GGB offers, along with the widest range of lubricated and self-lubricating bearing products, a comprehensive technical and application engineering knowledge.

In this respect, our Application Engineers can assist you in:

- Choosing the right type of plain bearing for your application
- Design of the bearing according to standard dimensions or to customer specific requirements
- Establishing a life time estimate
- Assembly and installation recommendations

Thanks to our global production and supply network, we are able to offer customers throughout the world the industry's most extensive range of self-lubricating and prelubricated plain bearings for literally thousands of applications in scores of industries.

As a reliable supplier with flexible manufacturing, we can respond quickly to customer needs with either standard or customized products.

Our advanced R&D and testing facilities help us deliver comprehensive solutions and assure their performance, reliability and cost-effectiveness. Our high performance bearing specialists have the experience and expertise to provide innovative solutions to even the most challenging applications.



Applications

AuGlide®, SY and SP bearings are perfectly suited to a wide range of applications.

AUGLIDE®, AND SY

The bimetallic structure of AuGlide® and SY bearings offers a bearing with very high mechanical strength, fatigue and wear resistance. AuGlide® and SY bearings are particularly recommended for lubricated applications working under extreme loads including shock loads and low speed oscillating movements.

Typical applications include:

Agricultural machinery, earth-movers, textile machinery, pneumatic equipment, king pin bushes, brake caliper bushes, mechanical handling and lifting equipment, hydraulic cylinders, off-highway equipment etc.

SP

The specific overlay composition of SP bearings make them suitable for high speed lubricated applications for which good emergency running is required.

Typical applications include:

Oil pump bearings, gearbox bushes, steering gear, power steering, pedal bushes, king pin bushes, tailgate pivots, brake caliper bushes, machine slides, hydraulic cylinders, hydraulic motors, pneumatic equipment, medical equipment, textile machinery, etc.

Material Structure



AuGlide®, copper bismuth on steel lead-free bearings with high load capacity and excellent wear resistance. Innovative bimetal bearing for harsh operating conditions.

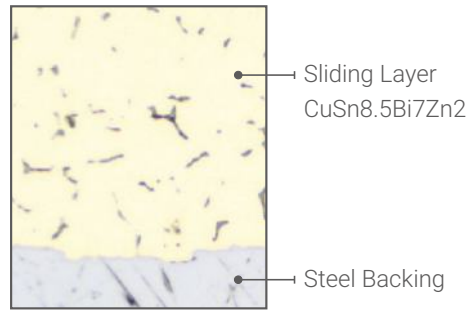

Fig. 1: AuGlide® Microsection

SY and SP are bimetal plain bearing materials each consisting of a steel backing to which is sintered a lead bronze sliding layer.

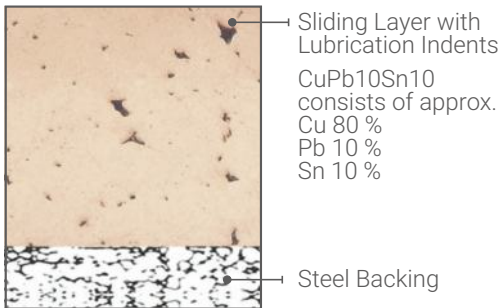

Fig. 2: SY Microsection

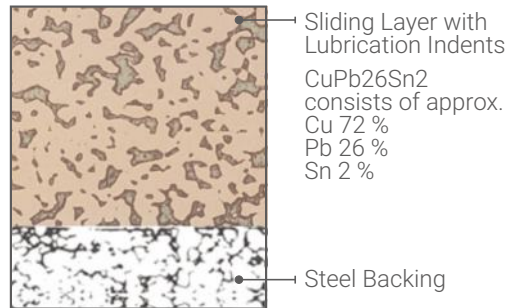

Fig. 3: SP Microsection

Available Forms

SY is available as a standard range of cylindrical wrapped bushes and thrust washers in metric sizes.

Non standard parts, strip and special forms to order.

AuGlide® and SP can be ordered as metric and inch bushes, strip and special forms.



Characteristics

AUGLIDE® AND SY

- Capable of supporting high specific loads
- Excellent fatigue strength under dynamic and shock load conditions
- Suitable for oil and grease lubrication
- Superior performance under oscillating movement
- Steel backing provides strength and rigidity
- Thin wall construction permits compact bearing assembly
- Indents in the bearing surface provide a reservoir for grease and thus allow extended re-greasing intervals
- Tolerant of relatively poor mating surface finish

SP

- Bush bore may be bored, reamed, broached or ball burnished in situ to control the assembled bearing clearance
- Suitable for oil or grease lubrication
- Steel backing provides strength and rigidity
- Hardened shafts are not required
- Thin wall construction permits compact bearing assembly

Physical and Mechanical Properties

Typical sliding layer and bearing properties for AuGlide®, SY and SP products.



BEARING PROPERTIES		VALUE	AUGLIDE®	UNIT SY	SP
GENERAL					
Maximum load, p	Static	N/mm ²	300	300	250
	Dynamic	N/mm ²	140	140	120
Operating temperature	Min	°C	-40	-40	-40
	Max greased	°C	150	150	150
	Max oil lubricated	°C	250	250	250
GREASED / OIL LUBRICATED					
Maximum sliding speed, U		m/s	2.5	2.5	2.5
Maximum pU factor		N/mm ² x m/s	2.8	2.8	2.8
Coefficient of friction, f	Greased		0.05 - 0.12	0.05 - 0.12	0.05 - 0.12
	Oil lubricated		0.04 - 0.12	0.04 - 0.12	0.04 - 0.12
RECOMMENDATIONS					
Shaft surface roughness, Ra		µm	≤ 0.8	≤ 0.8	≤ 0.4
Shaft surface hardness	Normal			> 200 HB	
	For longer service life			> 350 HB	

Table 1: Physical and Mechanical Properties of AuGlide®, SY and SP

Installation

AuGlide® SY and SP bushes should be inserted into the bearing housing with the aid of a stepped mandrel. Care must be taken to insert the bush squarely into the housing to avoid damage to the bearing lining material. A slight lead-in chamfer should be machined in the housing and a smear of oil applied to the outside surface of the bush to assist the fitting operation. Recommended mandrel and chamfer dimensions are given in figure 4.

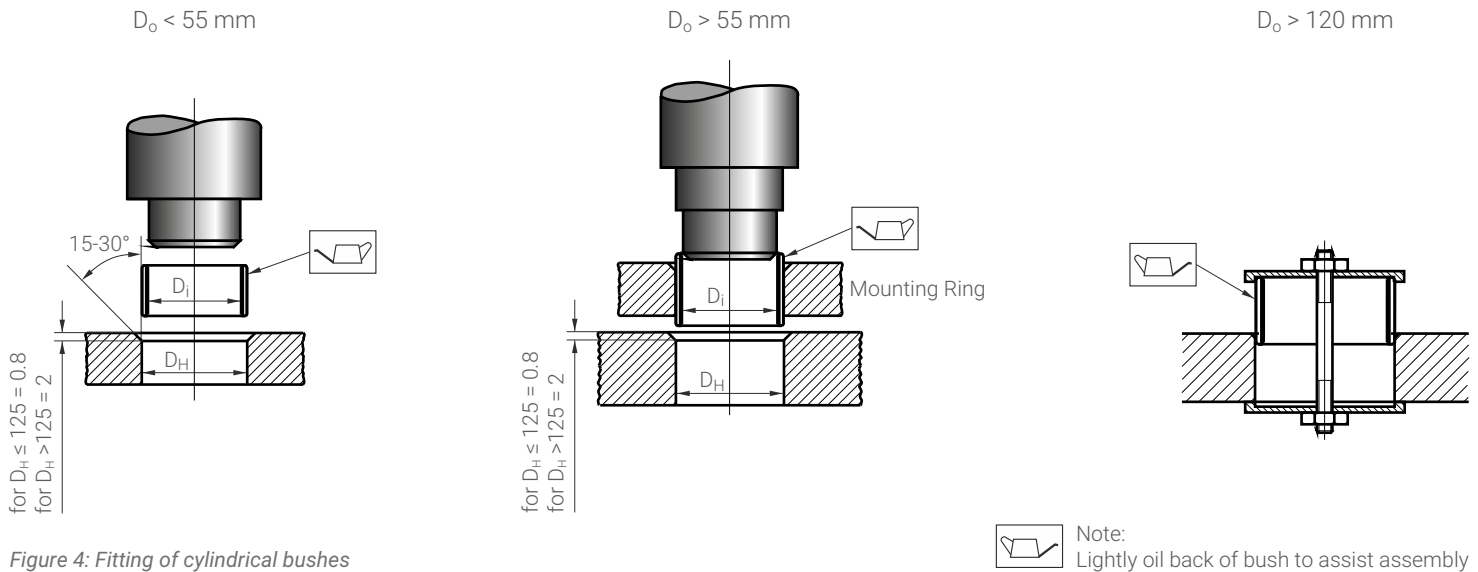

Figure 4: Fitting of cylindrical bushes

Lubrication

AuGlide® SY and SP bearings must be lubricated. Care should be taken at temperatures above 100°C to avoid attack of the bearing lining by any acidic degradation products from the lubricant. Unlike polymer composite bearing materials these materials are suitable for use with lubricants containing MoS₂ or graphite.

AUGLIDE® AND SY

Suitable for use with oil or grease lubrication. For use with grease lubrication, the bearing surface is manufactured with a uniform pattern of indents which form a reservoir for the lubricant and provide the optimum distribution within the loaded area of the bearing.

SP

Suitable for use with oil or grease lubrication. Particularly suitable for high speed applications with oil lubrication.

Cutting and Machining

AUGLIDE® AND SY

AuGlide® and SY bushes do not normally require sizing after assembly.

Should machining of the bearing lining be required then care should be taken to avoid any burrs around the edges of the indents in the bearing surface.

A diamond tipped boring tool should be used with a fine feed of 0.1 mm/rev. and a cutting speed of 2 - 3 m/s.

SP

The bushes must be finish sized after assembly. This may be done by burnishing, broaching or boring as described below.

For many applications burnishing with a hardened sphere or spherically ended or ribbed tool will give adequate bore size. The required diameter (d_1) of the burnishing tool is as shown on the right to allow for recovery of the bearing bore after sizing.

If boring is carried out, care must be taken to maintain good concentricity with the housing. It is advisable to use H6 limits and work towards the maximum bore size.

The cutting tool should have a small point radius, approximately 0.7 mm, an approach angle of 30°, primary angle of 10° and a cutting speed of 2 - 3 m/s, with a fine speed of 0.1 mm/rev.

d_1 calibration tool = $D_i + 0.0015$ mm

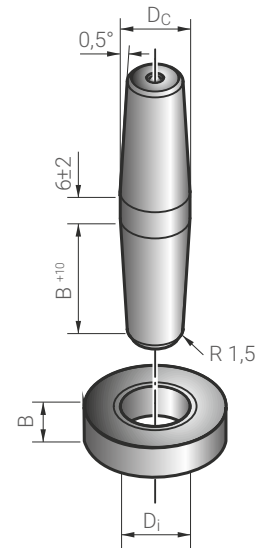

Cutting tool-geometry

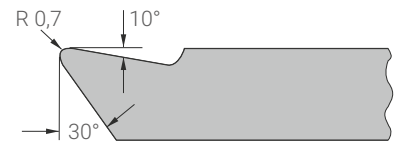

Cutting speed 2 - 3 m/s

Product Information

GGB gives an assurance that the products described in this document have no manufacturing errors. The details set out in this document are registered to assist in assessing the material's suitability for the intended use. They have been developed from our own investigations as well as from generally accessible publications. They do not represent any assurance for the properties themselves.

Unless expressly declared in writing, GGB gives no warranty that the products described are suited to any particular purpose or specific operating circumstances. GGB accepts no liability for any losses, damages or costs however they may arise through direct or indirect use of these products.

GGB's sales and delivery terms and conditions, included as an integral part of quotations, stock and price lists, apply absolutely to all business conducted by GGB. Copies can be made available on request.

Products are subject to continual development. GGB retains the right to make specification amendments or improvements to the technical data without prior announcement.

Edition 2020 (This edition replaces earlier editions which hereby lose their validity).

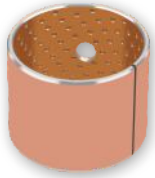

SY

AuGlide® cylindrical bearings
are available on order

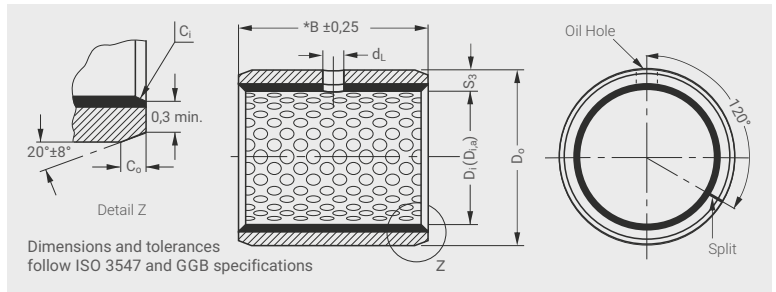

PART NO.	TECHNICAL DATA								
	Nominal Diameter		Wall Thickness S ₃ max. min.	Width B	Shaft-Ø D _J , h8 max. min.	Housing-Ø D _H , H7 max. min.	Bush-Ø D _{i,a} Ass. in H7 housing max. min.	Clearance C _D max. min.	Oil Hole Ø d _L
	D _i	D _o							
PM2015SY	20	23	1.490 1.430	15	20.000	23.021	+ 0.161 + 0.020	0.194 0.020	4
PM2025SY	20	23		25	19.967	23.000			
PM2030SY	20	23		30					
PM2215SY	22	25		15					
PM2220SY	22	25		20	22.000	25.021			
PM2225SY	22	25		25	21.967	25.000			
PM2230SY	22	25		30					
PM2515SY	25	28		15					
PM2520SY	25	28		20	25.000	28.021			
PM2525SY	25	28		25	24.967	28.000			
PM2530SY	25	28	30						
PM2815SY	28	32	1.980 1.920	15			+ 0.185 + 0.040	0.218 0.040	6
PM2820SY	28	32		20	28.000	32.025			
PM2825SY	28	32		25	27.967	32.000			
PM2830SY	28	32		30					
PM3015SY	30	34		15					
PM3020SY	30	34		20	30.000	34.025			
PM3025SY	30	34		25	29.967	34.000			
PM3030SY	30	34		30					
PM3040SY	30	34		40					
PM3230SY	32	36		30	32.000	36.025			
PM3240SY	32	36	40	31.961	36.000				
PM3515SY	35	39	1.980 1.920	15			+ 0.185 + 0.040	0.224 0.040	6
PM3520SY	35	39		20					
PM3525SY	35	39		25					
PM3530SY	35	39		30	35.000	39.025			
PM3535SY	35	39		35	34.961	39.000			
PM3540SY	35	39		40					
PM3545SY	35	39		45					
PM3550SY	35	39		50					
PM4020SY	40	44		20					
PM4030SY	40	44		30	40.000	44.025			
PM4040SY	40	44	40	39.961	44.000				
PM4050SY	40	44	50						
PM4060SY	40	44	60						
PM4530SY	45	50	2.460 2.400	30			+ 0.230 + 0.080	0.276 0.080	8
PM4540SY	45	50		40	45.000	50.025			
PM4550SY	45	50		50	44.961	50.000			
PM4560SY	45	50		60					
PM5020SY	50	55		20					
PM5030SY	50	55		30	50.000	55.030			
PM5040SY	50	55		40	49.961	55.000			
PM5050SY	50	55		50					
PM5060SY	50	55		60					
PM5535SY	55	60		35					
PM5540SY	55	60	40	55.000	60.030				
PM5555SY	55	60	55	54.954	60.000				
PM5560SY	55	60	60						
PM6030SY	60	65	30						
PM6040SY	60	65	40	60.000	65.030				
PM6060SY	60	65	60	59.954	65.000				
PM6070SY	60	65	70						
PM6540SY	65	70	40						
PM6550SY	65	70	50	65.000	70.030				
PM6560SY	65	70	60	64.954	70.000				
PM6570SY	65	70	70						

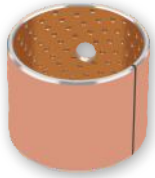

SY

AuGlide® cylindrical bearings are available on order

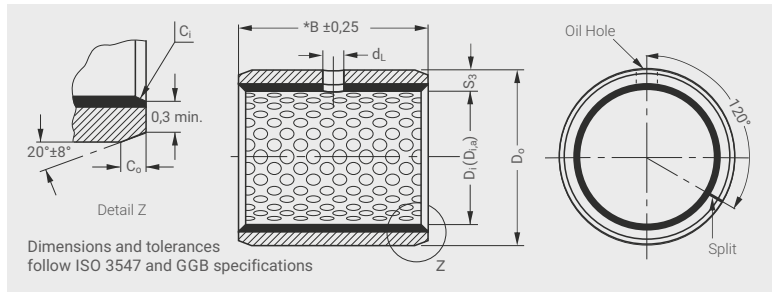

PART NO.	TECHNICAL DATA									
	Nominal Diameter		Wall Thickness S ₃ max. min.	Width B	Shaft-Ø D _J , h8		Housing-Ø D _H , H7	Bush-Ø D _{i,a} Ass. in H7 housing		Oil Hole Ø d _L
	D _i	D _o			max.	min.		max.	min.	
PM7030SY	70	75	2.460 2.400	30	70.000 69.954	75.030 75.000	+ 0.230 + 0.080	0.276 0.080	8	
PM7040SY	70	75		40						
PM7045SY	70	75		45						
PM7050SY	70	75		50						
PM7065SY	70	75		65						
PM7080SY	70	75		80						
PM7540SY	75	80		40	75.000 74.954	80.030 80.000				
PM7560SY	75	80		60						
PM7580SY	75	80		80						
PM8040SY	80	85		40	80.000 79.954	85.035 85.000	0.281 0.080			
PM8060SY	80	85		60						
PM8075SY	80	85		75						
PM8080SY	80	85		80						
PM8560SY	85	90		60	85.000 85.946	90.035 90.000	+ 0.235 + 0.080	0.289 0.080	9.5	
PM9040SY	90	95		40						
PM9070SY	90	95		70						
PM9090SY	90	95		90						
PM10040SY	100	105		40	100.000 99.946	105.035 105.000				
PM10050SY	100	105		50						
PM10060SY	100	105		60						
PM10080SY	100	105	80							
PM10095SY	100	105	95							
PM12050SY	120	125	50	120.000 119.946	125.040 125.000	+ 0.240 + 0.080	0.294 0.080			
PM13560SY	135	140	60	135.000 134.937	140.040 140.000		0.303 0.080			

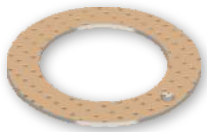

SY

AuGlide® washers are available on order

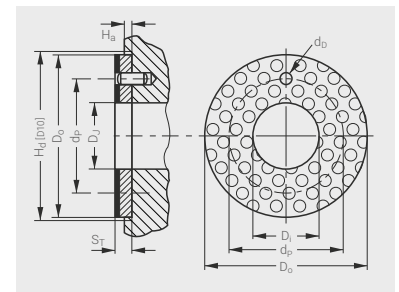

PART NO.	TECHNICAL DATA						
	Inside Ø D _i		Thickness S _T	Dowel Hole Ø D _D		Pitch Circle Ø d _p	Recess Depth H _a
	max.	min.		max.	min.		
WC30SY	32.00	32.25	1.45 1.41	4.125 4.375	43.12	0.95 1.20	
WC35SY	38.00	38.25			49.88		
WC40SY	42.00	42.25			53.88		
WC45SY	48.00	48.25	1.95 1.92		61.12	1.45 1.70	
WC50SY	52.00	52.25			64.88		

Bearing Application Data Sheet

Not sure which GGB part fits your application requirements?

Please complete the form below and share it with your GGB sales person or distributor representative.

DATA FOR BEARING DESIGN CALCULATION

Application: _____

Project/No.: _____ Quantity: _____ New Design Existing Design

Steady load Rotating load Rotational movement Oscillating movement Linear movement

DIMENSIONS [MM]

Inside diameter	D_i
Outside diameter	D_o
Length	B
Flange Diameter	D_{fl}
Flange thickness	B_{fl}
Wall thickness	S_T
Length of slideplate	L
Width of slideplate	W
Thickness of slideplate	S_s

LOAD

Static load
 Dynamic load

Axial load F	[N]
Radial load F	[N]

MOVEMENT

Rotational speed	N [1/min]
Speed	U [m/s]
Length of stroke	L_s [mm]
Frequency of stroke	[1/min]
Oscillating cycle	ϕ [°]
Osc. frequency	N_{osz} [1/min]

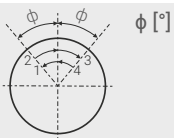

MATING SURFACE

Material	
Hardness	HB/HRC
Surface finish	Ra [µm]

FITS & TOLERANCES

Shaft	D_J
Bearing housing	D_H

OPERATING ENVIRONMENT

Ambient temperature	T_{amb} [°]
Bearing housing material	

Housing with good heating transfer properties
 Light pressing or insulated housing with poor heat transfer properties
 Non metal housing with poor heat transfer properties
 Alternate operation in water and dry

LUBRICATION

Dry
 Continuous lubrication
 Process fluid lubrication
 Initial lubrication only
 Hydrodynamic conditions

Process fluid	
Lubricant	
Dynamic viscosity	η [mPas]

SERVICE HOURS PER DAY

Continuous operation	
Intermittent operation	
Operating time	
Days per year	

SERVICE LIFE

Required service life	L_H [h]
-----------------------	-----------

BEARING TYPE

Cylindrical bush

Flanged bush

Thrust washer

Slideplate

Special parts (sketch)

CUSTOMER INFORMATION

Company _____
 Street _____
 City / State / Province / Post Code _____
 Telephone _____ Fax _____
 Name _____
 Email Address _____ Date _____

PUSHING BOUNDARIES TO CO-CREATE A HIGHER QUALITY OF LIFE

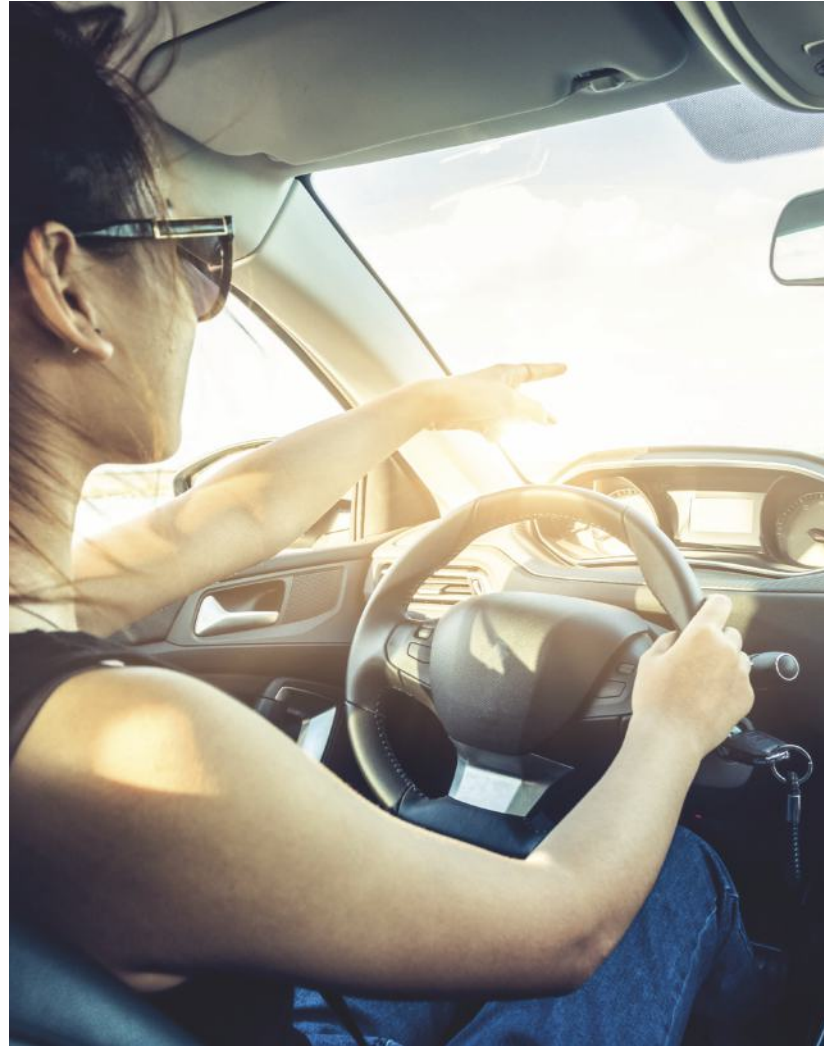

GGB NORTH AMERICA

P.O. Box 189 | 700 Mid Atlantic Parkway

USA | Thorofare, New Jersey, 08086

Tel: +1 856 848 3200

www.ggbearings.com



IN112ENG03-23USA